

ATX™ PRE Series 16 Amp Plugs and Sockets

Increased Safety

ATEX/IECEX:
Zone 1 and 2 - 21 and 22
 Ⓢ II 2 GD
IP66 - IK09/10

Applications

- Plugs and receptacles are used with portable or stationary electrical equipment such as:
 - Lighting systems
 - Conveyors
 - Heaters
 - Motor generators
 - Air conditioning equipment
 - Compressors
 - Pumps
- For use in corrosive atmospheres and installations in Zone 1 and 2 and 21 and 22 of the oil and gas industry; such as:
 - Refineries
 - Chemical and petrochemical plants
 - Pipelines
 - Loading docks
 - Onshore and offshore drilling platforms

Features

- Plug and socket system is designed with a safe disconnect mechanism to insure maximum hazardous location protection:
 - The contact separation is in a flameproof chamber
 - The automatic electrical disconnection of each phase is contained in a second flameproof chamber
- Short circuit protection is 20 kA, while normal reference is 10 kA.
- Different voltages are color coded for easy identification.
- The receptacles are keyed to accept only ATX plugs (other plugs can not be inserted).
- ATX plugs can be used in non-hazardous IEC 309 sockets.
- Operating temperature of -40 °C to +55 °C (-40 °F to +131 °F)

Standard Materials

- Wall Socket for 2P - 2P+E - 3P: high impact resistance polycarbonate
- Wall Socket for 3P+E - 3P+N+E: high impact resistance fiberglass reinforced polyester
- Plug, mobile socket and flush socket: polyamide

ATEX/IECEX Certifications and Compliances

- Certification Type PCX (Plug, socket and mobile socket)
 - Gas: Zones 1 and 2
 - Conforming to ATEX 94/9/CE: Ⓢ II 2 G
 - Type of Protection: Ex de IIC
 - Temperature Class: T6 for Ta ≤ +40 °C (-40 °F) and T5 for +55 °C (+131 °F)
 - Dust: Zones 21 and 22
 - Conforming to ATEX 94/9/CE: Ⓢ II 2 D
 - Type of Protection: Ex tD A21
 - Surface Temperature: T68 °C (T154 °F)
 - Impact Resistance (shock): IK10 (Polyester) and IK09 (Polyamide)
 - CE Declaration of Conformity: 50228
 - ATEX Certificate: LCIE 02 ATEX 6068
 - IECEX Certificate: IECEX LCI 04.0014
- Certification Type PCX/EN (Flush socket)
 - Gas: Zones 1 and 2
 - Conforming to ATEX 94/9/CE: Ⓢ II 2 G
 - Type of Protection: Ex de IIC
 - Temperature Class: T6 for Ta ≤ +40 °C (-40 °F) and T5 for +55 °C (+131 °F)



Plug



Wall Mounting Socket



Mobile Socket



Flush Socket

Technical Data

Breaking Capacity	
AC 3	4 kW – 220 V
	4.3 kW – 240 V
	7.5 kW – 380 V
	8.2 kW – 415 V
ICC	20 kA

- Dust: Zones 21 and 22
- Conforming to ATEX 94/9/CE: Ⓢ II 2 D
- Type of Protection: Ex tD A21
- Surface Temperature: T68 °C (T154 °F)
- Impact Resistance (shock): IK09 (Polyamide)
- CE Declaration of Conformity: 5C214
- ATEX Certificate: LCIE 02 ATEX 0001U
- IECEX Certificate: IECEX LCI 07.0012U
- Ambient Temperature: -40 °C ≤ Ta ≤ +55 °C (-40 °F ≤ Ta ≤ +131 °F)
- Index of Protection according EN/IEC 60529: IP66

EURASEC Certification

- Certification Type PCX (Plug, socket and mobile socket)
 - EURASEC N° TC RU G-FR.ГБ05.В.00910
- Certification Type PCX/EN (Flush socket)
 - EURASEC N° TC RU G-FR.ГБ05.В.00910

Other Certification

- Certification Type PCX (Plug, socket and mobile socket)
 - INMETRO Certificate: BVC11.0639 ①
- Certification Type PCX/EN (Flush socket)
 - INMETRO Certificate: BVC11.0598-U ①

① INMETRO certification available on special request only. Contact your local sales representative for more information.

ATX™ PRE Series 16 Amp Plugs and Sockets

Increased Safety

ATEX/IECEX:
 Zone 1 and 2 - 21 and 22
 II 2 GD
 IP66 - IK09/10



Wall Mounting Socket

- Three M20 threaded entries (one on the top and two on the bottom).
- Supplied with one M20 cable gland – Ø 6.5 to Ø 14.5 mm (Ø 0.26 to Ø 0.57") and two M20 blanking plugs.
- Terminal capacity 2 x 4 mm² (0.003 x 0.006 in²). Can be through-wired.
- Fitted with three linked earth terminals.



Plug

- One PG16 integrated cable gland – Ø 6.5 to Ø 14.5 mm (Ø 0.26 to Ø 0.57").
- Terminal capacity 2.5 mm² (0.004 in²).



Mobile Socket

- One PG16 integrated cable gland – Ø 6.5 to Ø 14.5 mm (Ø 0.26 to Ø 0.57").
- Terminal capacity 2 x 4 mm² (0.003 x 0.006 in²).



Flush Socket

- Terminal capacity 2 x 4 mm² (0.003 x 0.006 in²).

Catalog Numbering Guide - IECEX Internationally Certified Plugs and Receptacles

PRE
 IECEX Series:
 PRE - PRE Series
 Zone 1, 2, 21 and 22
 ATEX / IECEX

2
 Pin Configuration:
 2 - 2P
 3 - 2P+E
 4 - 3P+E
 5 - 3P+N+E
 6 - 3P

16
 Amps:
 16 - 16A

R
 Equipment:
 P - Plug
 R - Receptacle
 (Wall Mounting)
 M - Mobile Socket
 F - Flush Socket

P
 Voltage:
 P - 20 - 25 Vac 50/60 Hz
 W1 - 20 - 50 Vdc
 W - 40 - 50 Vac 50/60 Hz
 Y - 100 - 130 Vac 50/60 Hz
 B - 200 - 250 Vac 50/60 Hz
 R - 380 - 415 Vac 50/60 Hz
 N - 480 - 500 Vac 50/60 Hz
 G - 50 - 500 Vac 300 to 500 Hz

ELV: Extra Low Voltage

Purple	White	White
20/25 Vac	20/50 Vdc	40/50 Vac

LV: Low Voltage

Yellow	Blue	Red	Black	Green
100/130 Vac	200/250 Vac	380/415 Vac	480/500 Vac	50/500 Vac (300 to 500 Hz)

PLUGS AND RECEPTACLES: ATEX/IECEX INCREASED SAFETY







ATX™ PRE Series 16 Amp Plugs and Sockets

Increased Safety

ATEX/IECEX:
Zone 1 and 2 - 21 and 22
II 2 GD
IP66 - IK09/10

PLUGS AND RECEPTACLES: ATEX/IECEX INCREASED SAFETY

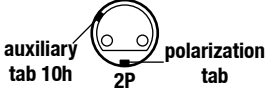
Appleton®

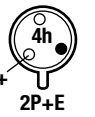
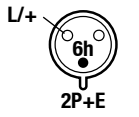
Description	Pin Configuration	Weight kg (lb)	Volume dm ³ (in ³)	Catalog Number
Extra Low Voltage: ELV				
20/25 Vac 50/60 Hz — Purple				
Wall Socket		0.6 (1.3)	3.8 (231.89)	PRE216RP
Plug		0.2 (0.4)	0.6 (361.6)	PRE216PP
Mobile Socket		0.4 (0.9)	1.3 (79.33)	PRE216MP
Flush Socket		0.2 (0.4)	1.3 (79.33)	PRE216FP
Wall Socket		0.6 (1.3)	3.8 (231.89)	PRE316RP
Plug		0.2 (0.4)	0.6 (36.61)	PRE316PP
Mobile Socket		0.4 (0.9)	1.3 (79.33)	PRE316MP
Flush Socket		0.2 (0.4)	1.3 (79.33)	PRE316FP
Wall Socket		0.6 (1.3)	3.8 (231.89)	PRE616RP
Plug		0.2 (0.4)	0.6 (36.61)	PRE616PP
Mobile Socket		0.4 (0.9)	1.3 (79.33)	PRE616MP
Flush Socket		0.2 (0.4)	1.3 (79.33)	PRE616FP
20/50 Vdc — White				
Wall Socket		0.6 (1.3)	3.8 (231.89)	PRE216RW1
Plug		0.2 (0.4)	0.6 (36.61)	PRE216PW1
Mobile Socket		0.4 (0.9)	1.3 (79.33)	PRE216MW1
Flush Socket		0.2 (0.4)	1.3 (79.33)	PRE216FW1
40/50 Vac 50/60 Hz — White				
Wall Socket		0.6 (1.3)	3.8 (231.89)	PRE216RW
Plug		0.2 (0.4)	0.6 (36.61)	PRE216PW
Mobile Socket		0.4 (0.9)	1.3 (79.33)	PRE216MW
Flush Socket		0.2 (0.4)	1.3 (79.33)	PRE216FW
Wall Socket		0.6 (1.3)	3.8 (231.89)	PRE616RW
Plug		0.2 (0.4)	0.6 (36.61)	PRE616PW
Mobile Socket		0.4 (0.9)	1.3 (79.33)	PRE616MW
Flush Socket		0.2 (0.4)	1.3 (79.33)	PRE616FW
Low Voltage: LV				
100/130 Vac 50/60 Hz — Yellow				
Wall Socket		0.6 (1.3)	3.8 (231.89)	PRE316RY
Plug		0.2 (0.4)	0.6 (36.61)	PRE316PY
Mobile Socket		0.4 (0.9)	1.3 (79.33)	PRE316MY
Flush Socket		0.2 (0.4)	1.3 (79.33)	PRE316FY
200/250 Vac 50/60 Hz — Blue				
Wall Socket		0.6 (1.3)	3.8 (231.89)	PRE316RB
Plug		0.2 (0.4)	0.6 (36.61)	PRE316PB
Mobile Socket		0.4 (0.9)	1.3 (79.33)	PRE316MB
Flush Socket		0.2 (0.4)	1.3 (79.33)	PRE316FB

ATX™ PRE Series 16 Amp Low Voltage Plugs and Sockets

Increased Safety

ATEX/IECEX:
 Zone 1 and 2 - 21 and 22
 II 2 GD
 IP66 - IK09/10

Description	Pin Configuration	Weight kg (lb)	Volume dm ³ (in ³)	Catalog Number
Low Voltage: LV				
200/250 Vac 50/60 Hz – Blue				
Wall Socket		1.5 (3.3)	4.7 (286.81)	PRE416RB
Plug		0.6 (1.3)	0.6 (361.6)	PRE416PB
Mobile Socket		0.6 (1.3)	4.0 (244.09)	PRE416MB
Flush Socket		0.2 (0.4)	1.3 (79.33)	PRE416FB
Wall Socket		1.6 (3.5)	4.7 (286.81)	PRE516RB
Plug		0.3 (0.7)	1.3 (79.33)	PRE516PB
Mobile Socket		0.6 (1.3)	4.0 (244.09)	PRE516MB
Flush Socket		0.2 (0.4)	1.3 (79.33)	PRE516FB
380/415 Vac 50/60 Hz – Red				
Wall Socket		1.5 (3.3)	4.7 (286.81)	PRE416RR
Plug		0.2 (0.4)	0.6 (361.6)	PRE416PR
Mobile Socket		0.6 (1.3)	4.0 (244.09)	PRE416MR
Flush Socket		0.3 (0.7)	1.3 (79.33)	PRE416FR
Wall Socket		1.6 (3.5)	4.7 (286.81)	PRE516RR
Plug		0.3 (0.7)	1.3 (79.33)	PRE516PR
Mobile Socket		0.6 (1.3)	4.0 (244.09)	PRE516MR
Flush Socket		0.3 (0.7)	1.3 (79.33)	PRE516FR
480/500 Vac 50/60 Hz – Black				
Wall Socket		1.5 (3.3)	4.7 (286.81)	PRE416RN
Plug		0.2 (0.4)	0.6 (361.6)	PRE416PN
Mobile Socket		0.6 (1.3)	4.0 (244.09)	PRE416MN
Flush Socket		0.3 (0.7)	1.3 (79.33)	PRE416FN
50/500 Vac 300/500 Hz – Green				
Wall Socket		1.6 (3.5)	4.7 (286.81)	PRE516RG
Plug		0.2 (0.4)	0.6 (361.6)	PRE516PG
Mobile Socket		0.6 (1.3)	4.0 (244.09)	PRE516MG
Flush Socket		0.3 (0.7)	1.3 (79.33)	PRE516FG
Accessories				
Description				
	M5 earth stud with black neoprene sealing washer and green/yellow earth conductor, length 300 mm (11.8")			PREESTM20
	M20 earth continuity adaptor with black neoprene sealing washer and green/yellow earth conductor, length 300 mm (11.8")			PREECAM20

PLUS AND RECEPTACLES: ATEX/IECEX INCREASED SAFETY



ATX™ PRE Series 16 Amp Plug and Socket

Increased Safety

ATEX/IECEX:
 Zone 1 and 2 - 21 and 22
 II 2 GD
 IP66 - IK09/10

Dimensions in Millimeters (Inches)

16A – 2P – 2P+E – 3P Versions

Wall Mounting Sockets

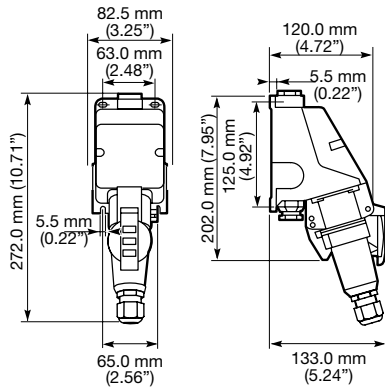

Plugs

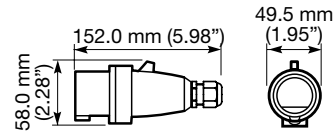

Mobile Sockets

Can be mounted on panel - 3.0 mm (0.12") thickness maximum

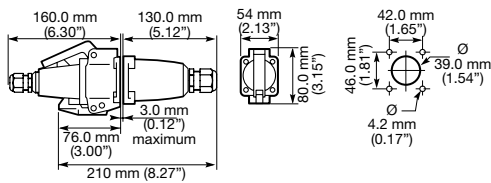

Flush Sockets

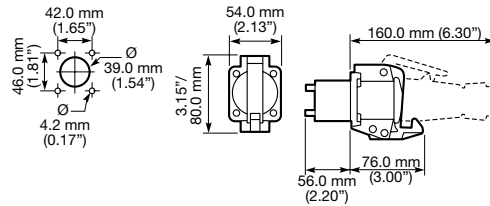

16A – 3P+E – 3P+N+E Versions

Wall Mounting Sockets

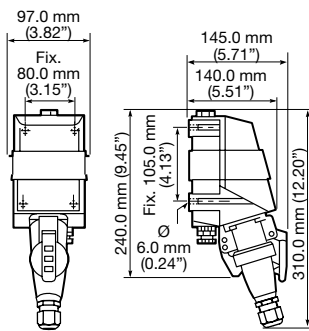

Plugs

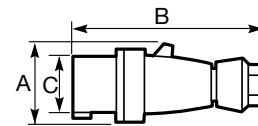

Dimensions in Millimeters (Inches)

	A	B	C
3 P + E	66.0 (2.60)	154.0 (6.06)	55.5 (2.19)
3 P + N + E	73.0 (2.87)	166.0 (6.54)	62.0 (2.44)

Mobile Sockets

Can be mounted on panel - 3.0 mm (0.12") thickness maximum

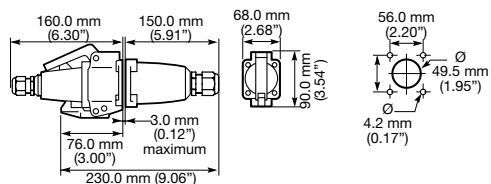

Flush Sockets

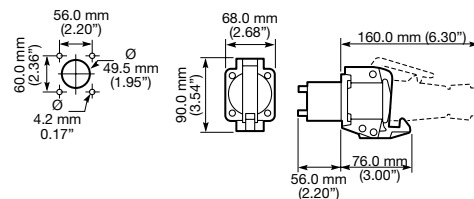

PLUGS AND RECEPTACLES: ATEX/IECEX INCREASED SAFETY

Appleton